



# UNIDRIVE M700



## Manufacturing Automation drive

Class leading induction and permanent magnet servo motor performance, with real-time Ethernet



- Unidrive M100
- Unidrive M200
- Unidrive M300
- Unidrive M400
- Unidrive M600
- Unidrive M700**
- Unidrive M800

0.75 kW – 2.8 MW Heavy Duty  
 (1.0 hp – 4,200 hp)  
 200 V | 400 V | 575 V | 690 V



The Unidrive M Manufacturing Automation drive family

## Unidrive M – The Manufacturing Automation drive family tailored to customer needs

Led by the results of extensive customer-driven market research, we have tailored seven Unidrive M feature-sets to specific application needs identified within Manufacturing Automation. The Unidrive M700 brings onboard real-time Ethernet, comprehensive position feedback and high performance control of dynamic permanent magnet servo motors to the range. It also provides a fully compatible upgrade for existing Unidrive SP users within Manufacturing Automation.

For more information on the full Unidrive M family, please download the Unidrive M Overview brochure or the 'Discover Unidrive M' App (available on the App Store, Android and online) via [www.UnidriveM.com](http://www.UnidriveM.com).

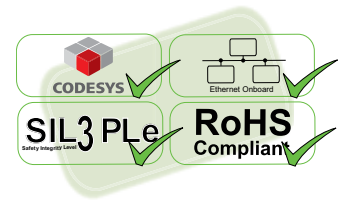

# Unidrive M700 features

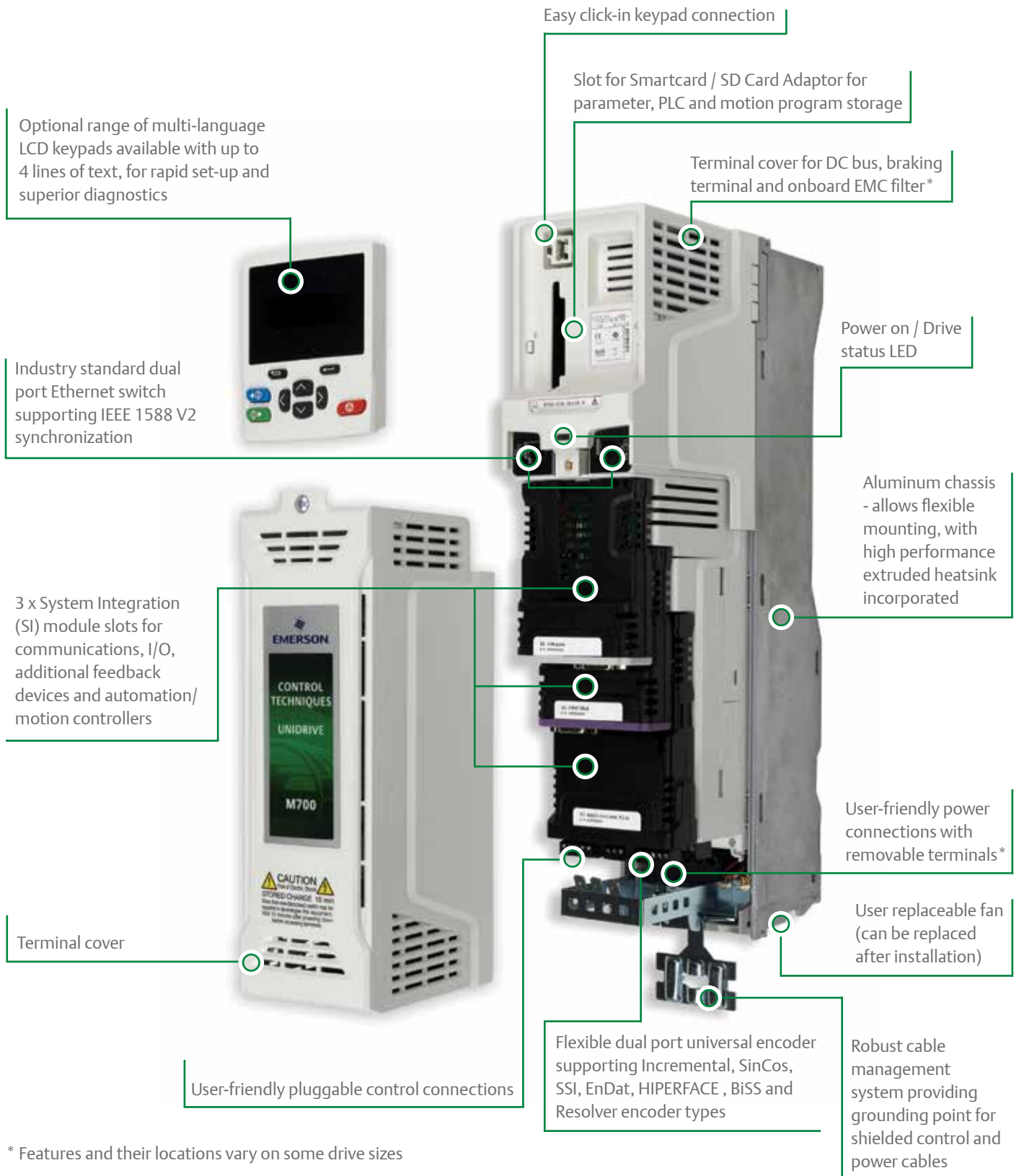

\* Features and their locations vary on some drive sizes

# Unidrive M700 AC and Servo drive

**Class leading induction and permanent magnet servo motor performance, with real-time Ethernet**

M700 delivers maximum machine throughput through precision motor control, onboard real-time Ethernet (IEEE 1588 V2 Precision Time Protocol), advanced motion control and high speed I/O for position capture, enabling machine builders to easily create more sophisticated and flexible machines.



## Unidrive M700 Highlights

### Maximum machine throughput with your choice of motor

Unidrive M maximizes machine throughput with exceptional control performance with virtually any industrial motor type:

- AC Induction Motors
- Permanent Magnet Motors
- Servo Motors
- Synchronous Reluctance Motors
- Linear Motors



Highly efficient permanent magnet motors from Leroy Somer

### Maximum choice and performance with the right encoder technology

Unidrive M700 allows you to choose the right encoder technology, based on performance and cost for your application. The onboard feedback interface provides high performance connectivity to multiple encoder channels and supports virtually any standard encoder feedback technology, including Resolver, BISS and EnDat devices.

Unimotor hd high dynamic brushless AC servo motor range







### Choice and performance with open technologies

Unidrive M Intelligent Machine Architecture adopts high performance, open technologies, for Ethernet networking and Machine Control programming, giving machine builders access to the widest pool of engineering talent and choice of automation components.

### Easy to access machine control features

Software tools, keypads and memory storage devices provide easy and fast access to Unidrive M's machine control features for configuration, monitoring and diagnostics.

### Add the extra features you need

Unidrive M700 supports up to three optional click-in System Integration (SI) modules that allow seamless integration with Manufacturing Automation systems and other vendor supplied equipment. Functions available include communications, additional I/O, feedback devices, enhanced safety features and scalable motion control.



## Intelligent Machine Architecture – Open technology, exceptional performance

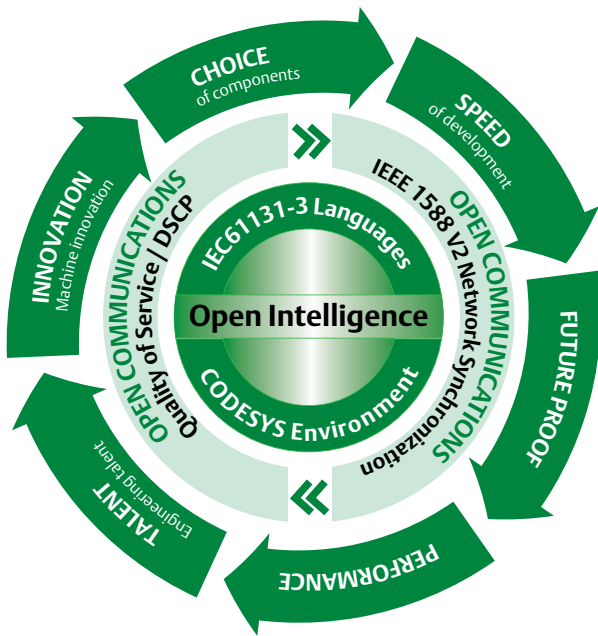

Control Techniques Intelligent Machine Architecture is an open approach to automation, designed to maximize machine throughput. This is achieved through a synchronized high performance network of intelligent control devices, sensors and actuators, linked together through open and globally available, industry standard Ethernet. Open standards provide significant benefits to machine builders and OEMs:

- Choice to select the ‘best-in-class’ for every machine component
- Familiarity with standards accelerates machine development and innovation
- Broad acceptance of open standards makes it easier to recruit skilled engineering staff with the required expertise

### How is Intelligent Machine Architecture different?

- Standard networking hardware - no limits on integration possibilities
- Performance without effort - ease of use is prioritized with high level software tools that are proven to speed up machine development and maximize machine performance
- Increased network efficiency - intelligence is networked and not centralized, removing traffic bottlenecks
- Inclusive networking - support for EtherNet/IP, Modbus TCP/IP and PROFINET RT\* allows interaction with the widest range of automation equipment from a global pool of automation providers
- Only leading technologies - Intelligent Machine Architecture is based on feedback from customers and adopts only the leading open standards throughout

### IEC 61131-3 motion and automation programming

Unidrive M offers the choice to integrate machine control functionality within the drive:

- Simple onboard CODESYS based PLC
- Advanced 1.5 axis Motion Controller, key features include:
  - ⇒ 250  $\mu$ s cycle time
  - ⇒ Motion profile generator
  - ⇒ Electronic gearbox
  - ⇒ Interpolated CAM
  - ⇒ Homing function
  - ⇒ High speed position freeze
- High performance MCI200 and MCI210 Machine Control modules for extra control performance

\* Future availability



Unidrive M700's onboard real-time Ethernet (using IEEE 1588 V2) provides improved machine control with fast and flexible communications. Synchronization can be achieved across the network below 1  $\mu$ s, with update rates as low as 250  $\mu$ s with a virtually unlimited node count.



**Transformer core cutting line**

## Machine Control Studio Software - Powered by CODESYS

Control Techniques Machine Control Studio provides a flexible and intuitive environment for programming Unidrive M's new automation and motion control features. The new software offers programming for:



- Unidrive M700's onboard PLC
- High performance MCI200 and MCI210 Machine Control modules
- Ethernet network data configurations

Machine Control Studio is powered by CODESYS, the leading open software for programmable machine control. The programming environment is fully IEC 61131-3 compliant, meaning that it is familiar and therefore fast and easy to use for control engineers around the world.

The following IEC 61131-3 programming languages are supported:

- Structured Text (ST)
- Function Block Diagram (FBD)
- Structured Function Chart (SFC)
- Ladder Diagram (LD)
- Instruction List (IL)

Also supported:

- Continuous Function Chart (CFC)

Intuitive IntelliSense functionality helps to write consistent and robust programming, speeding up software development. Programmers have access to a vibrant open-source community for function blocks. Control Techniques also provides support for customers' own function block libraries, with on-line monitoring of program variables with user defined watch windows and help for on-line change of program, in line with current PLC practice.

Features	Unidrive M onboard	MCI module
Breakpoints	No	Yes
Source code upload/download	No	Yes
Online change	No	Yes
Trigonometric functions	No	Yes
64 bit data types	No	Yes
Real-time task(s)	Yes (min 4ms)	Yes (min 250 $\mu$ s)
Customizable drive menu	Yes (menu 30)	Yes (Menu 27, 28, 29)
Variable tracing	No	Yes
Tasks available	1 x Freewheeling task, 1 x Clock task	1 x Freewheeling task, 1 x Position task, 1 x Initial task, 4 x Clock tasks, 1 x Error task, 4 x Event tasks



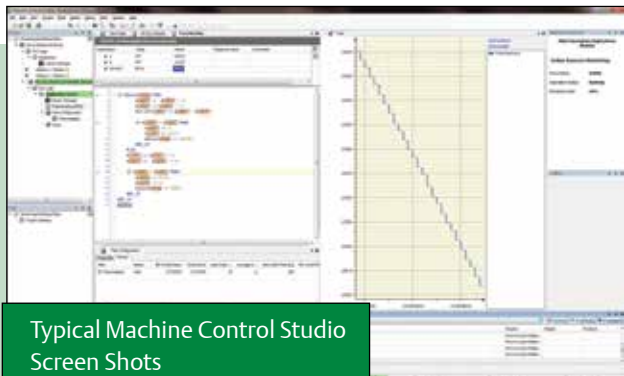

Typical Machine Control Studio Screen Shots



## Open, efficient, synchronized Ethernet

Control Techniques Intelligent Machine Architecture uses standard Ethernet to connect the machine controller parts and other devices such as PCs, I/O and HMIs together. Ethernet provides machine builders and manufacturers with real benefits:

- Maximize machine productivity through high performance deterministic Ethernet, suitable for complete Machine Automation and demanding synchronized motion functions.
- Access future developments in IT based industries where billions of nodes are installed, future proofing your investments.
- Access to a massive choice of network monitoring and diagnostics tools.

Through advances in Ethernet technology, standard Ethernet hardware now delivers the highest levels of machine performance in industrial networking. For communication between drives, PCs, I/O and other devices, Unidrive M uses open protocols such as TCP/IP and UDP, delivering exceptional performance:

- Network synchronization of less than  $1 \mu\text{s}$  (typically  $<200 \text{ ns}$ )
- $250 \mu\text{s}$  cycle time for the most demanding motion applications
- Virtually unlimited node count
- Bandwidth protection through a network gateway that manages non-real-time Ethernet messages
- Master/follower and peer-to-peer communications capabilities



**Printing application**

## Network synchronization

Network synchronization is a common requirement across many industries including industrial automation, entertainment, telecommunications and power generation. This requirement led to the development of the Precision Time Protocol (PTP) standard which provides a mechanism for precisely synchronizing clocks across all PTP capable nodes in an Ethernet network. PTP is defined by the international standard IEEE 1588 V2.

The wide range of applications for PTP has driven demand for chip manufacturers to provide network controllers that economically support this protocol. This has led to a massive and increasing choice of networking products that cost-effectively integrate PTP, including industrial Ethernet switches and I/O. Unidrive M integrates PTP onboard the drive within a dual port Ethernet switch enabling high precision synchronization across the Ethernet network.

### IEEE 1588 V2 clock explanation

IEEE 1588 V2 distributed clocks are used to automatically synchronize the position, speed and current loops across all drives.

## Traffic management

### Manage non-critical network traffic through a network gateway

Unidrive M integrates a network gateway feature within the drive's dual port switch. This uses standards called Differentiated Services Code Point (DSCP) and Quality of Service (QoS) to protect network bandwidth by eliminating or delaying non-critical messages from outside the control network.

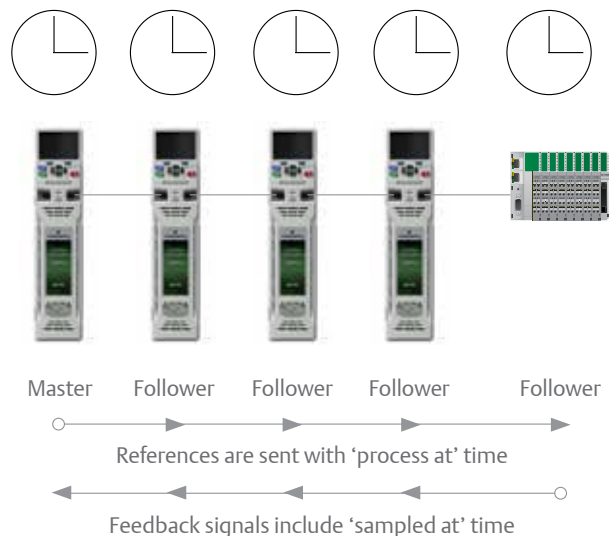

# Unidrive M Flexible Ethernet Communications

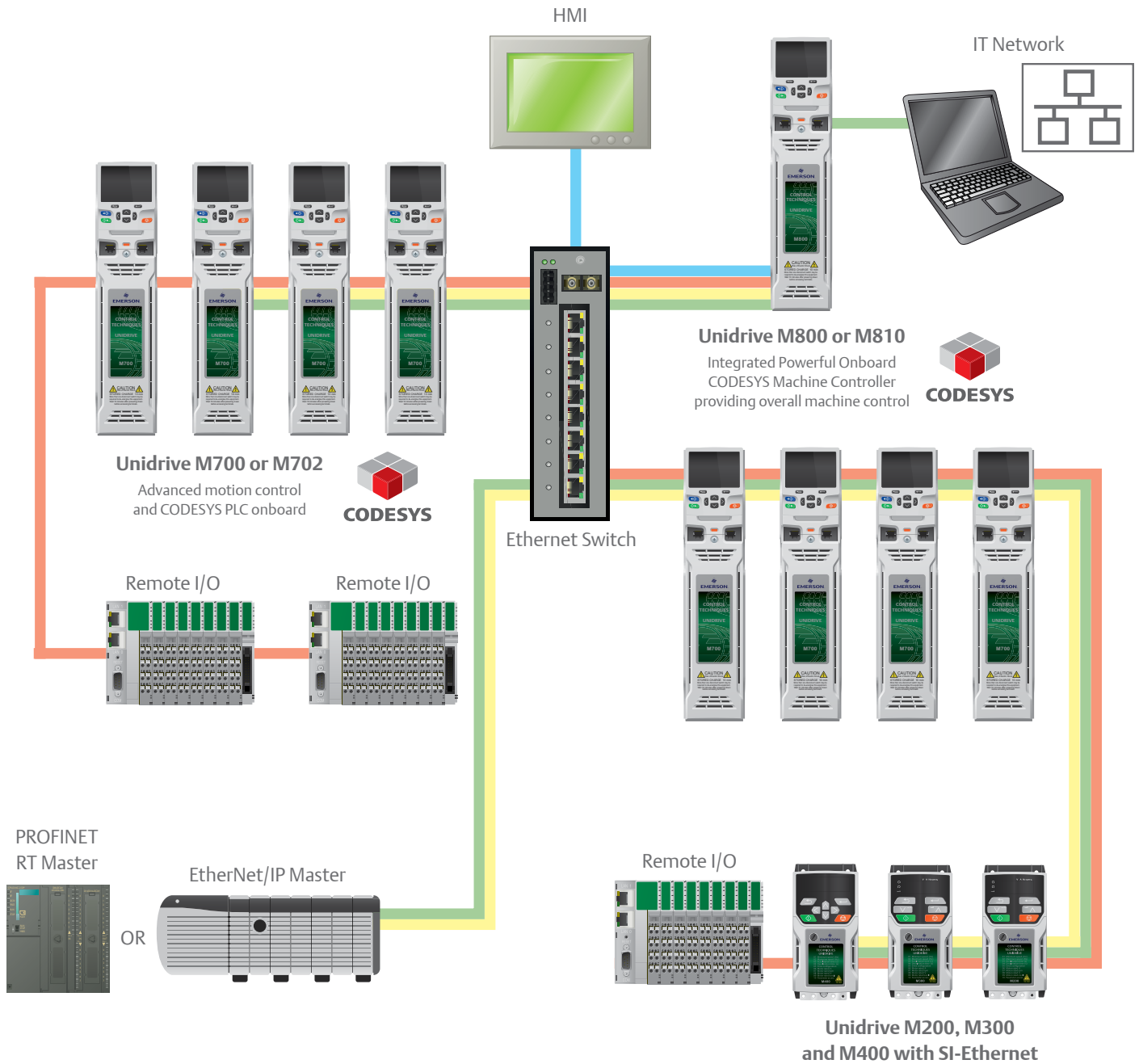

- Synchronized communications using IEEE 1588 V2 PTP
- PROFINET RT\* or EtherNet/IP communications
- Modbus TCP/IP communications
- IT communications - Managed using QoS to ensure network reliability

System Integration (SI) option modules allow additional connectivity with EtherCAT, PROFIBUS, DeviceNet, CANopen and I/O. Plus connectivity to legacy CTNet system

\* Future availability



## Enhanced Machine Integration

### Scalable Safety

Machine safety features enhance machine throughput while protecting people and assets, helping to meet SIL3 (Safety Integrity Level 3). The M700 offers alternative levels of integrated safety functions to suit various manufacturing needs, reducing external components and machine costs.

- Safe Torque Off (STO) inputs provide an easy entry level for safety integration.
- The SI-Safety module\* provides an intelligent programmable solution to meet the IEC 61800-5-2 functional safety standard, covering numerous functions including STO, Safe Stop 1 and 2, Safe Limited Speed and Safe Speed Monitor.

\* Future release

### Flexible universal encoder port

Increase flexibility and reduce system costs through simultaneously connecting up to three\*\* high performance encoder channels as standard. As an example, the drive can interface with a feedback encoder, reference encoder and provide

a simulated encoder output without the need for additional System Integration modules.

- Two universal encoder input channels
  - ◇ Support for standard incremental and SinCos encoders, including those with absolute commutation signals.
  - ◇ Support for communications based encoders with up to a 4 Mbaud rate and line compensation for long cable lengths of up to 100 m.
  - ◇ Support includes BiSS C, EnDat 2.2, HiPerFace and SSI
  - ◇ Resolver support for feedback in harsh environments.
- One simulated encoder output
  - ◇ Position reference for CAMs, digital lock and electronic gearbox applications.
  - ◇ Implemented through hardware to maximize performance.

\*\*The functionality is dependent upon the encoder types being used



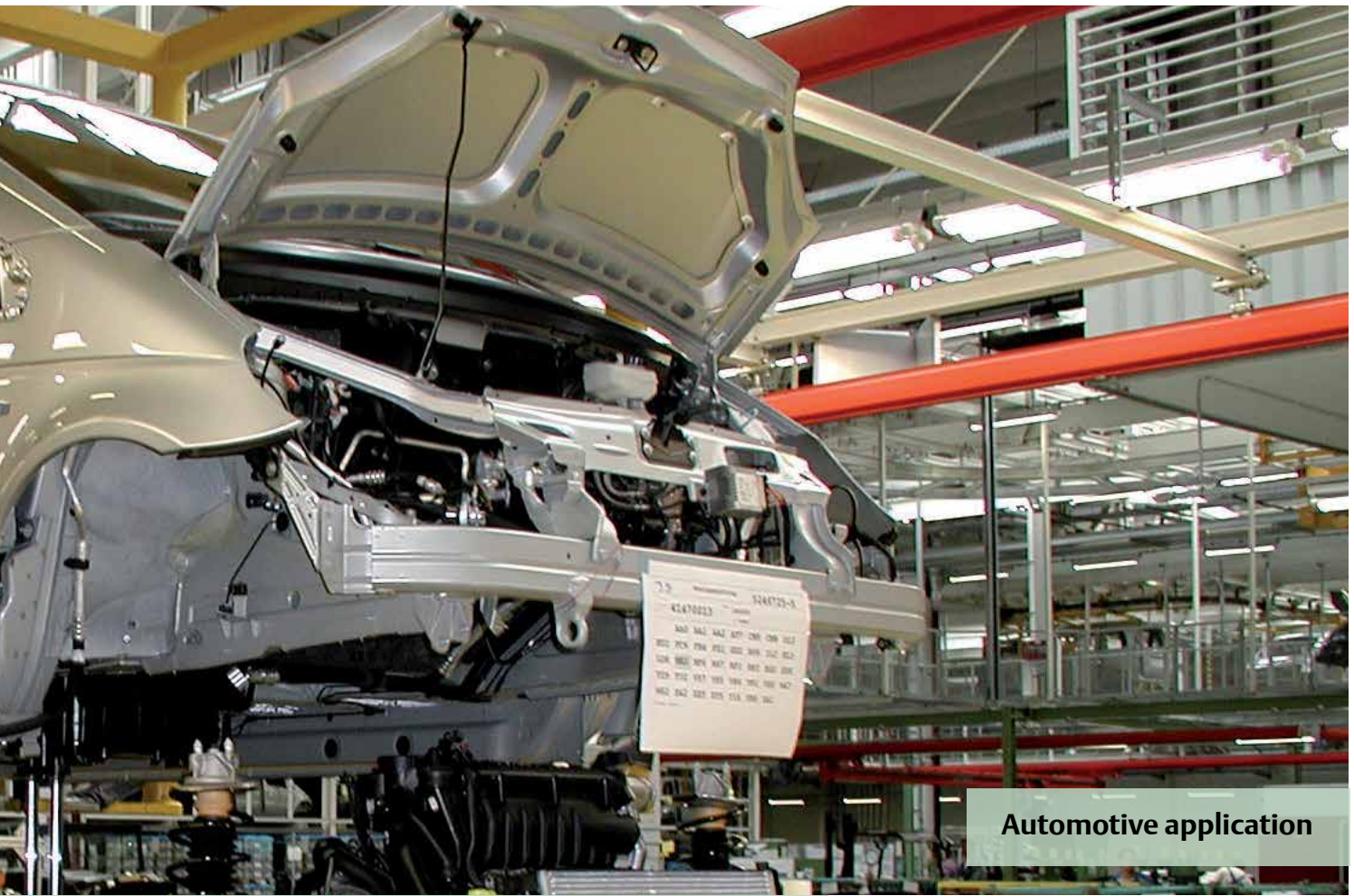

Automotive application

## Power System Flexibility

Unidrive M's power stage enhances flexibility and energy efficiency

- Easy common DC bus configuration enables braking energy to be recycled within the drive system, reducing energy usage and eliminating external supply components. This economic method also provides a minimum footprint for a multiple drives solution.
- Unidrive M can run with a wide operating DC voltage input, from 24 V up to maximum Volts, providing optimum choice of auxiliary power supply for back-up purposes.
- Low losses, up to 98% efficient.
- Low power standby mode. In some applications, drives can sit idle for significant periods; M700's reduced standby power saves energy.
- M700 supports sensorless (open loop) control of compact high efficiency permanent magnet motors.
- Active Front End to return braking energy to the power supply and minimize harmonic distortion.



Common DC bus configuration enables braking energy to be recycled within the drive system

## Control Mode

Open loop vector or V/Hz induction motor control  
Open loop Rotor Flux Control for induction motors (RFC-A)



Closed loop permanent magnet motor control (RFC-S)



Open loop permanent magnet motor control (RFC-S)



Closed loop Rotor Flux Control for induction motors (RFC-A)



Active Front End (AFE)  
power quality converter



## Optional Drive Programming and Operator Interface

Unidrive M Connect



KI-Keypad



KI-Keypad RTC



Remote Keypad



Operator Interface



Smartcard



SD Card using SD Card Adaptor



KI-485 Adaptor



## Centralized PLC /Motion Control

Motion Controller



PLC



Industrial Computer



## Optional Input/Output

Remote I/O

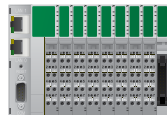

SI-I/O



4 x Digital I/O  
3 x Analog input (default) /  
Digital input  
1 x Analog output (default)  
/ Digital input  
2 x Relay

Standard



5 x Analog I/O  
8 x Digital I/O  
(including 2 x high  
speed I/O [250 μs])  
1 x Relay output  
1 x STO



### Applications with PLC or Motion Functionality

**Standard**

Easy to use onboard PLC and advanced motion control using industry standard CODESYS programming environment



SI-Applications Plus compatible module which allows existing SyPTPro application programs to be re-compiled for M700



MCI200 Advanced machine control using industry standard CODESYS programming environment



MCI210 Extended advanced machine control using industry standard CODESYS programming environment with simultaneous connectivity to 2 separate Ethernet networks



### Communications

**Standard**

Ethernet (IEEE 1588 V2)  
PROFINET RT\*  
Modbus TCP/IP  
EtherNet/IP  
TCP/IP  
UDP



SI-EtherCAT



SI-PROFIBUS



SI-Ethernet



SI-DeviceNet



SI-CANopen



SI-PROFINET



**Safety**

SI-Safety



**Feedback**

**Standard**

2 x universal encoder input channels  
Support includes BISS C, EnDat 2.2, HIPERFACE and SSI

1 x simulated encoder output



SI-Encoder



SI-Universal Encoder



### DC back-up power supply

24 - 1067 Vdc power



24 Vdc control



\*Future availability.



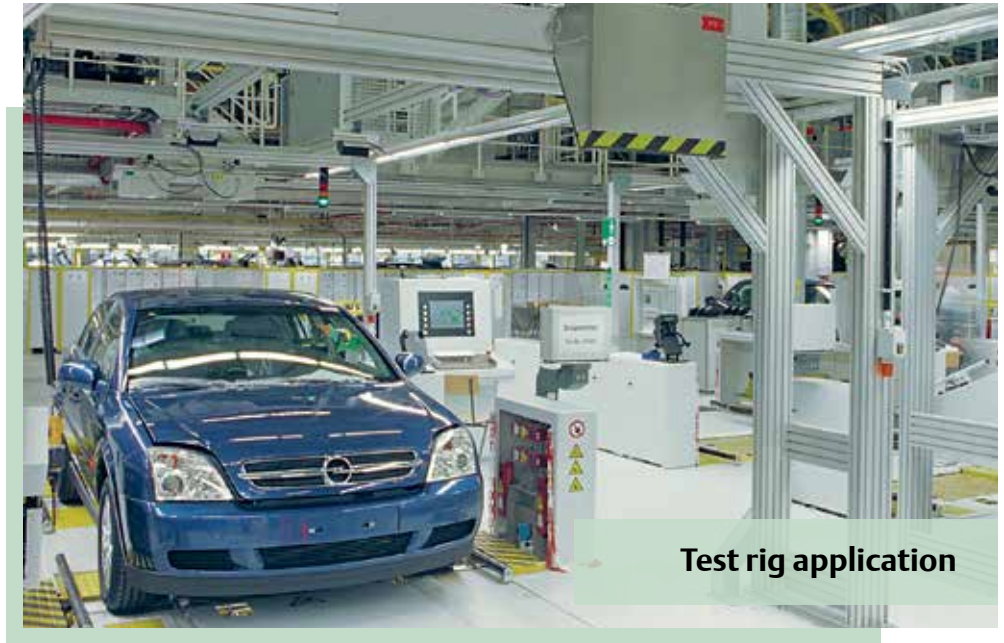



**Test rig application**

**Fast and Easy access for Commissioning, Monitoring and Diagnostics**  
 Unidrive M keypads, memory devices and software tools make it easy to access Unidrive M700's full feature set, allowing users to optimize drive tuning, back-up the configuration set and troubleshoot more quickly.

**User interface options**

Unidrive M benefits from a number of optional keypad choices to meet your application needs.

Type		Benefit
KI-Keypad: Removable plain text LCD keypad		Plain text, multi-language LCD keypad for in depth parameter and data descriptions for an enhanced user experience.
KI-Keypad RTC: Removable plain text LCD with real-time clock		All the features of the KI-Keypad, but with battery operated real-time clock. This allows accurate time stamping of events, aiding diagnostics.
Remote Keypad		Remote mountable, plain text, multi-language LCD keypad allows flexible mounting on the outside of a panel and meets IP66 (NEMA 4).



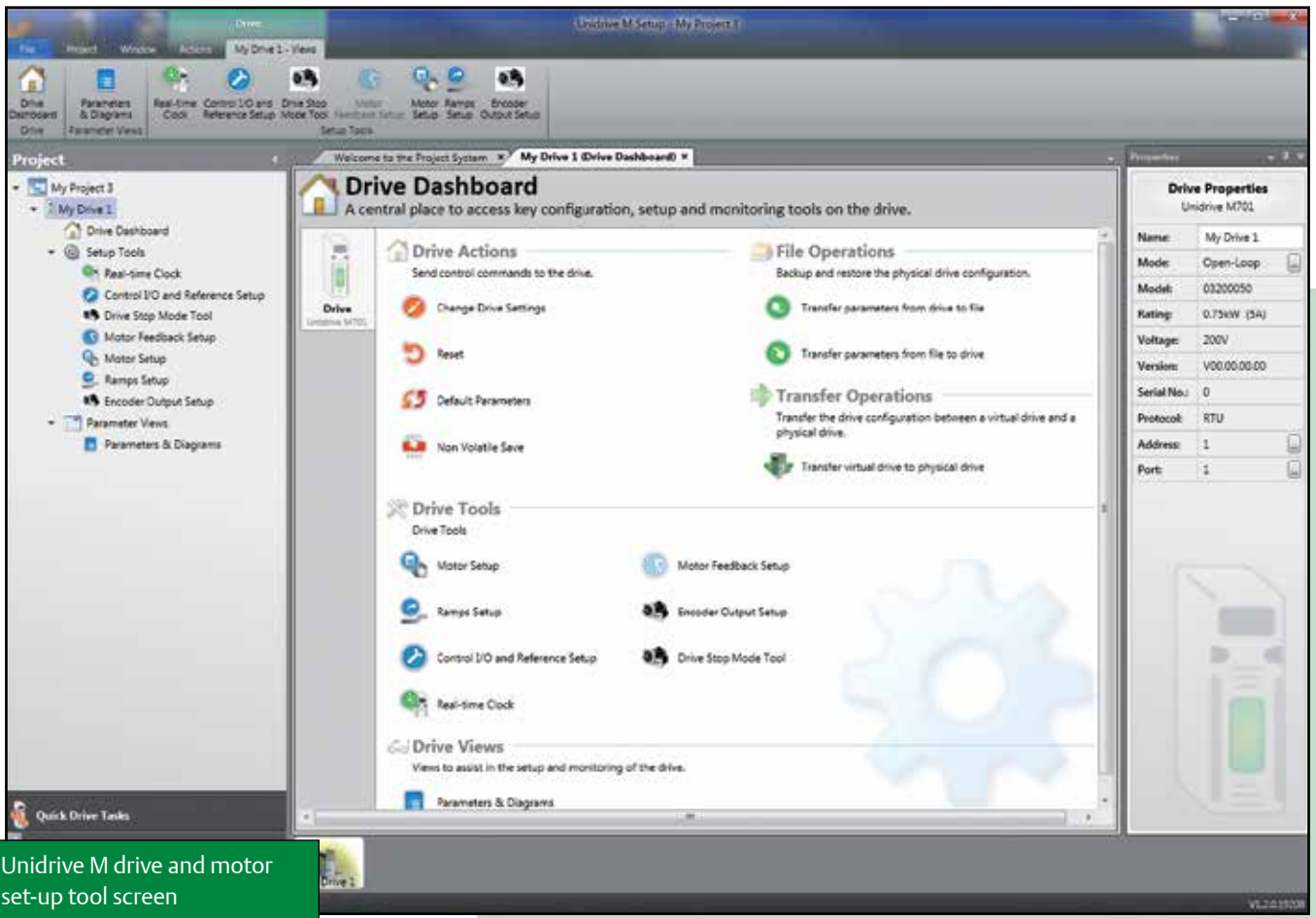

## Unidrive M Connect commissioning tool

Based on Control Techniques' 25 years of experience, Unidrive M Connect is our latest drive configuration tool for commissioning, optimizing and monitoring drive/system performance. Its development draws from extensive user research, using human centered design principals to give the ultimate user experience:

- Fast task based commissioning and easy maintenance of the Unidrive M family is simplified via familiar Windows interface
- Intuitive graphical tools enhance and simplify user experience
- For experienced users, dynamic drive logic diagrams and enhanced searchable listings are present
- Drive and motor performance can be optimized with minimal specialized drive knowledge
- Tool is scalable to match application requirements
- Supports the import of Unidrive SP parameter files and allows full drive cloning (i.e. parameter sets and application program)
- Multiple simultaneous communications channels for a more complete overview of the system

- Drive discovery gives the ability to find drives on a network automatically without the user having to specify their addresses
- Automatic RTU baud rate scanning on the M701 RS485 connection

## Unidrive M's portable memory devices Smartcard

The optional Smartcard memory device can be used to back-up parameter sets and basic PLC programs, as well as copying them from one drive to another. It also allows:

- Simplified drive maintenance and commissioning
- Quick set-up for sequential build of machines
- Machine upgrades to be stored on a Smartcard and sent to the customer for installation

## SD card

Unidrive M700 uses popular SD cards for quick and easy parameter and program storage using an SD Card Adaptor, allowing them to fit in the drive Smartcard slot. SD cards provide a huge memory capability allowing a complete system reload if required, and can be easily pre-programmed on a common PC.



**Laser cutting application**

## Select the M700 feature-set for your application

To maximize customer choice, the M700 offers the following 3 variants:

### M700 - Ethernet

Onboard real-time Ethernet is included on the standard M700, with 1 x Safe Torque Off (STO) and both analog and digital I/O, making it an incredibly versatile high performance AC drive.

### M701 - Unidrive SP replacement

Designed to match Control Techniques' highly popular Unidrive SP feature-set. This includes RS485 communications, 1 x STO, analog and digital I/O, identical control connectors, with Unidrive SP Smartcard parameter sets supported to make upgrading to Unidrive M as simple as possible.

### M702 - Safety Enhanced

The safety enhanced M702 has 2 x STO, onboard real-time Ethernet and digital I/O; where easy integration with modern control and safety systems is paramount. If analog I/O is required, this can be provided by an SI-I/O option module.

### Powerful and easy field service and upgrade

The M700 is designed to extend the field service life of previous generations of products. It also provides the easiest possible upgrade for OEM machine designs that currently use Unidrive SP drives.

- M701 provides a direct upgrade path from Unidrive SP:
  - ⇒ RS485 communications
  - ⇒ 1 x STO terminal
  - ⇒ Analog and digital I/O

- Unidrive M700 and M701 are able to take a Smartcard (parameter copying device) from Unidrive SP and import drive settings.
- Unidrive M700 and M701 have the same control connector terminal layout as Unidrive SP.
- The SI-Applications Plus module allows existing Unidrive SP SyPTPro programs to be easily recompiled for Unidrive M700.
- Unidrive M700 has more compact dimensions than Unidrive SP. However, easy retrofit is ensured as fixing points for existing Unidrive SP installations can be used either with standard Unidrive M mounting brackets or optional conversion kits where required.

## Performance control for every motor

Control Techniques' unique motor control algorithms combined with the latest microprocessor technology ensure that Unidrive M drives offer the highest stability and bandwidth for all industrial motor types. This enables you to maximize machine throughput in every application and with every motor, from standard AC induction motors to dynamic linear motors and from energy saving permanent magnet motors to high performance servo motors.

- Unidrive M700 can compensate for mechanical load resonance in motors, ensuring optimal performance.
- High bandwidth motor control algorithm for open and closed loop induction, synchronous reluctance and PM servo motors with up to 3,300 Hz current loop bandwidth and 250 Hz speed loop bandwidth.

Motor control options available include:

Control Mode	Control Strategy	Features
Open loop vector or V/Hz induction motor control	Frequency Speed	Open loop motor control for induction motors, providing the easiest configuration. V/Hz can be used in multi-motor systems.
<b>Enhanced</b> open loop Rotor Flux Control for induction motors (RFC-A)	Speed Torque	Vector algorithm utilizing closed loop current control to greatly enhance performance for all induction motor sizes.
<b>New</b> open loop permanent magnet motor control (RFC-S)	Speed Torque Position	Open loop motor control for permanent magnet motors utilizing closed loop current control. This mode offers good dynamic performance and enables more compact and higher efficiency motor technologies to be used.  This mode also supports simple positioning without the need for encoder position feedback.
<b>Enhanced</b> closed loop Rotor Flux Control for induction motors (RFC-A)	Speed Torque Position	Dynamic speed or position control of induction motors, supporting a wide range of feedback devices.
<b>Enhanced</b> closed loop permanent magnet/servo motor control (RFC-S)	Speed Torque Position	Closed loop control of high efficiency and servo permanent magnet motors supporting a wide range of feedback devices. This mode also supports the control of Synchronous Reluctance Motors.
<b>Enhanced</b> Active Front End (AFE) Power Quality Converter	Regenerative	Active Front End (AFE) to return excess braking energy back onto the power line, reducing energy costs instead of dissipating this energy as heat. The AFE provides power factor control for power quality management and greatly reduces unwanted power harmonics.

### Unidrive M700 feature and specification table

Performance	Current loop update: 62 $\mu$ s	Feedback	2 x Encoder input and 1 x Simulated encoder output	
	Heavy Duty peak rating: 200 % (3s)		Onboard I/O	3 x Analog input, 2 x Analog output, 4 x Digital input, 1 x Digital output, 3 x Bidirectional digital input or output
	Maximum output frequency: 550 Hz			(M702: 3 x Digital input, 3 x Digital output and no Analog I/O)
	Switching frequency range: 2, 3, 4, 6, 8, 12, 16 kHz (3 kHz default)			1 x Relay output
	High performance current controllers			Machine safety
Onboard intelligence	Programmable Logic Control (PLC)	Power and motor control	Stationary autotune for permanent magnet motors	
	Real-time tasks		Mechanical load resonance compensation	
	Digital lock control		Wide operating range back-up DC supply	
	Advanced Motion Controller		24 V control back-up	
Onboard comms	Ethernet (2 switched ports), (M701: RS485)	Other	Temperature controlled fan operation with user adjustable speed limit	
Mechanical attributes	Tile mounting on sizes 3, 4, 5		User replaceable fan(s)	
	Unidrive SP compatible mechanical footprint either as standard or with conversion plates		Conformal coating	
	Common DC bus connections on sizes 3, 4, 5, 6		Standby mode (energy saving)	
Parameter back-up	Ethernet/serial port cloning			
	SD card (using SD-Card Adaptor)			
	Smartcard reader support			
	Electronic motor nameplate parameter storage (EnDat, HIPERFACE, BISS encoders)			

# Unidrive M700 ratings and specifications

200/240 Vac ±10%						
Drive	Heavy Duty			Normal Duty		
	Max Continuous Current (A)	Motor Shaft Power (kW)	Motor Shaft Power (HP)	Max Continuous Current (A)	Motor Shaft Power (kW)	Motor Shaft Power (HP)
M70x-03200050A	5	0.75	1	6.6	1.1	1.5
M70x-03200066A	6.6	1.1	1.5	8	1.5	2
M70x-03200080A	8	1.5	2	11	2.2	3
M70x-03200106A	10.6	2.2	3	12.7	3	3
M70x-04200137A	13.7	3	3	18	4	5
M70x-04200185A	18.5	4	5	24	5.5	7.5
M70x-05200250A	25	5.5	7.5	30	7.5	10
M70x-06200330A	33	7.5	10	50	11	15
M70x-06200440A	44	11	15	58	15	20
M70x-07200610A	61	15	20	75	18.5	25
M70x-07200750A	75	18.5	25	94	22	30
M70x-07200830A	83	22	30	117	30	40
M70x-08201160A	116	30	40	149	37	50
M70x-08201320A	132	37	50	180	45	60
M70x-09201760A*	176	45	60	216	55	75
M70x-09202190A*	219	55	75	266	75	100
M70x-09201760E	176	45	60	216	55	75
M70x-09202190E	219	55	75	266	75	100
M70x-10202830E	283	75	100	325	90	125
M70x-10203000E	300	90	125	360	110	150

380/480 Vac ±10%						
Drive	Heavy Duty			Normal Duty		
	Max Continuous Current (A)	Motor Shaft Power (kW)	Motor Shaft Power (HP)	Max Continuous Current (A)	Motor Shaft Power (kW)	Motor Shaft Power (HP)
M70x-03400025A	2.5	0.75	1	3.4	1.1	1.5
M70x-03400031A	3.1	1.1	1.5	4.5	1.5	2
M70x-03400045A	4.5	1.5	2	6.2	2.2	3
M70x-03400062A	6.2	2.2	3	7.7	3	5
M70x-03400078A	7.8	3	5	10.4	4	5
M70x-03400100A	10	4	5	12.3	5.5	7.5
M70x-04400150A	15	5.5	10	18.5	7.5	10
M70x-04400172A	17.2	7.5	10	24	11	15
M70x-05400270A	27	11	20	30	15	20
M70x-05400300A	30	15	20	30	15	20
M70x-06400350A	35	15	25	38	18.5	25
M70x-06400420A	42	18.5	30	48	22	30
M70x-06400470A	47	22	30	63	30	40
M70x-07400660A	66	30	50	79	37	50
M70x-07400770A	77	37	60	94	45	60
M70x-07401000A	100	45	75	112	55	75
M70x-08401340A	134	55	100	155	75	100
M70x-08401570A	157	75	125	184	90	125
M70x-09402000A*	200	90	150	221	110	150
M70x-09402240A*	224	110	150	266	132	200
M70x-09402000E	200	90	150	221	110	150
M70x-09402240E	224	110	150	266	132	200
M70x-10402700E	270	132	200	320	160	250
M70x-10403200E	320	160	250	361	200	300

\* Future availability



500/575 Vac ±10%						
Drive	Heavy Duty			Normal Duty		
	Max Continuous Current (A)	Motor Shaft Power (kW)	Motor Shaft Power (HP)	Max Continuous Current (A)	Motor Shaft Power (kW)	Motor Shaft Power (HP)
M70x-05500030A	3	1.5	2	3.9	2.2	3
M70x-05500040A	4	2.2	3	6.1	4	5
M70x-05500069A	6.9	4	5	10	5.5	7.5
M70x-06500100A	10	5.5	7.5	12	7.5	10
M70x-06500150A	15	7.5	10	17	11	15
M70x-06500190A	19	11	15	22	15	20
M70x-06500230A	23	15	20	27	18.5	25
M70x-06500290A	29	18.5	25	34	22	30
M70x-06500350A	35	22	30	43	30	40
M70x-07500440A	44	30	40	53	37	50
M70x-07500550A	55	37	50	73	45	60
M70x-08500630A	63	45	60	86	55	75
M70x-08500860A	86	55	75	108	75	100
M70x-09501040A*	104	75	100	125	90	125
M70x-09501310A*	131	90	125	150	110	150
M70x-09501040E	104	75	100	125	90	125
M70x-09501310E	131	90	125	150	110	150
M70x-10501520E	152	110	150	200	130	200
M70x-10501900E	190	132	200	200	150	200

500/690 Vac ±10%						
Drive	Heavy Duty			Normal Duty		
	Max Continuous Current (A)	Motor Shaft Power (kW)	Motor Shaft Power (HP)	Max Continuous Current (A)	Motor Shaft Power (kW)	Motor Shaft Power (HP)
M70x-07600190A	19	15	20	23	18.5	25
M70x-07600240A	24	18.5	25	30	22	30
M70x-07600290A	29	22	30	36	30	40
M70x-07600380A	38	30	40	46	37	50
M70x-07600440A	44	37	50	52	45	60
M70x-07600540A	54	45	60	73	55	75
M70x-08600630A	63	55	75	86	75	100
M70x-08600860A	86	75	100	108	90	125
M70x-09601040A*	104	90	125	125	110	150
M70x-09601310A*	131	110	150	150	132	175
M70x-09601040E	104	90	125	125	110	150
M70x-09601310E	131	110	150	155	132	175
M70x-10601500E	150	132	175	172	160	200
M70x-10601780E	178	160	200	197	185	250

\* Future availability

## Heavy Duty

Suitable for demanding applications, current overload of 200% is available for dynamic loads.

## Normal Duty

Suitable for most applications, with a current overload capacity of 110%.

For a full explanation of the drive order code, refer to page 27.

# Unidrive M700 ratings and specifications

## Environmental safety and electrical conformance

- IP20 / NEMA1 / UL TYPE 1\*  
\*UL open class as standard, additional kit needed to achieve Type 1
- IP65 / NEMA4 / UL TYPE 12 rating is achieved on the rear of the drive when through panel mounted
- Ambient temperature -20 °C to 40 °C as standard. Up to 55 °C with derating
- Humidity 95 % maximum (non-condensing) at 40 °C
- Altitude: 0 to 3000m, derate 1 % per 100 m between 1000 m and 3000 m
- Random Vibration: Tested in accordance with IEC 60068-2-64
- Mechanical Shock Tested in accordance with IEC 60068-2-29
- Storage temperature -40 °C to 70 °C
- Electromagnetic Immunity complies with EN 61800-3 and EN 61000-6-2
- With onboard EMC filter, complies with EN 61800-3 (2nd environment)
- EN 61000-6-3 and EN 61000-6-4 with optional footprint EMC filter
- IEC 60146-1-1 Supply conditions
- IEC 61800-5-1 (Electrical Safety)
- IEC 61131-2 I/O
- Safe Torque Off, independently assessed by TÜV to IEC 61800-5-2 SIL 3 and EN ISO 13849-1 PL
- UL 508C (Electrical Safety)

## Optional media and accessories

Description	Order code
SD Card Adaptor	
Smartcard (64 kB)	2214-0010

## Internal brake resistor

Frame size	Order code
3	1220-2752
4 & 5	1299-0003

## DC bus paralleling kit

Frame size	Order code
3	3470-0048
4	3470-0061
5	3470-0068
6	3470-0063
6 (connect to frame 3,4 & 5)	3470-0111

## Through hole IP65 kit

Frame size	Order code
3	3470-0053
4	3470-0056
5	3470-0067
6	3470-0055
7	3470-0079
8	3470-0083
9E & 10	3470-0105
10 Inverter	3470-0108
10 Rectifier	3470-0106

## Tile mount kit

Frame size	Order code
3	3470-0049
4	3470-0060
5	3470-0073

## UL Type 1 Conduit kit

Frame size	Order code
3 & 4	6521-0071
5	3470-0069
6	3470-0059
7	3470-0080
8	6500-0106
9E & 10	3470-0115

## Retrofit brackets

To allow Unidrive M drives to be fitted in existing Unidrive SP surface mount installations.

Frame size	Order code
4	3470-0062
5	3470-0066
6	3470-0074
7	3470-0078
8	3470-0087
9E & 10	3470-0118

## Cable grommet kit

Frame size	Order code
7	3470-0086
8 - Single cable	3470-0089
8 - Dual cable	3470-0090
9E & 10	3470-0107

## General kit items

Item	Order code
Keypad blanking cover (10 pieces in pack)	3470-0058
Frame size 3 & 4 power connector split kit	3470-0064
Frame 3 through hole multi-axis kit **	3470-0065
I/O commissioning extender adaptor	3000-0009

\*\* To allow multiple drives to be through hole mounted with no space between them.

## Optional external EMC filters

Unidrive M built-in EMC filter complies with EN 61800-3. External EMC filters are required for compliance with EN 61000-6-4.

Frame size	Voltage	Order code
3	200 V	4200-3230
	400 V	4200-3480
4	200 V	4200-0272
	400 V	4200-0252
5	200 V	4200-0312
	400 V	4200-0402
	575 V	4200-0122
6	200 V	4200-2300
	400 V	4200-4800
	575 V	4200-3690
7	200 V & 400 V	4200-1132
	575 V & 690 V	4200-0672
8	200 V & 400 V	4200-1972
	575 V & 690 V	4200-1662
9	200 V & 400 V	4200-3021
	575 V & 690 V	4200-1660
9E & 10	200 V & 400 V	4200-4460
	575 V & 690 V	4200-2210

For a full list of patents and patent applications, visit [www.controltechniques.com/patents](http://www.controltechniques.com/patents).

# Dimensions, weight and frame size ratings



Frame size		3	4	5	6	7	8	
Dimensions (H x W x D)	mm	382 x 83 x 200	391 x 124 x 200	M200 to M400 391 x 143 x 192 M600 to M800 391 x 143 x 200	M200 to M400 391 x 210 x 221 M600 to M800 391 x 210 x 227	557 x 270 x 280	803 x 310 x 290	
	in	15.0 x 3.3 x 7.9	15.4 x 4.9 x 7.9	M200 to M400 15.4 x 5.6 x 7.6 M600 to M800 15.4 x 5.6 x 7.6	M200 to M400 15.4 x 8.3 x 8.7 M600 to M800 15.4 x 8.3 x 8.9	21.9 x 10.6 x 11.0	31.6 x 12.2 x 11.4	
Weight	kg (lb)	4.5 (9.9) Max	6.5 (14.3)	7.4 (16.3)	14 (30.9)	28 (61.7)	52 (114.6)	
Line Choke	Internal	•	•	•	•	•	•	
	External							
	@ 200 V	0.75 kW - 2.2 kW (1 hp - 3 hp)	3 kW - 4 kW (3 hp - 5 hp)	5.5 kW (7.5 hp)	7.5 kW - 11 kW (10 hp - 15 hp)	15 kW - 22 kW (20 hp - 30 hp)	30 kW - 37 kW (40 hp - 50 hp)	
	@ 400 V	0.75 kW - 4 kW (1 hp - 5 hp)	5.5 kW - 7.5 kW (10 hp)	11 kW - 15 kW (20 hp - 25 hp)	18.5 kW - 22 kW (30 hp)	30 kW - 45 kW (50 hp - 75 hp)	55 kW - 75 kW (100 hp - 125 hp)	
	@ 575 V			1.5 kW - 4 kW (2 hp - 5 hp)	5.5 kW - 22 kW (7.5 hp - 30 hp)	30 kW - 37 kW (40 hp - 50 hp)	45 kW - 55 kW (60 hp - 75 hp)	
	@ 690 V					15 kW - 45 kW (20 hp - 60 hp)	55 kW - 75 kW (75 hp - 100 hp)	

All dimensions include mounting brackets except for the DIN rail alternative for frames 1 and 2.



# MODULAR DRIVES

## INVERTER & RECTIFIER



	9A*	9E	10	11*	9	10	11*
	1108 x 310 x 290	1069 x 310 x 288	1069 x 310 x 288	1410 x 310 x 310	1069 x 310 x 289	1069 x 310 x 289	1410 x 310 x 310
	43.6 x 12.2 x 11.4	42.1 x 12.2 x 11.3	42.1 x 12.2 x 11.3	55.5 x 12.2 x 12.2	42.1 x 12.2 x 11.4	42.1 x 12.2 x 11.4	55.5 x 12.2 x 12.2
		46 (101.4)	46 (101.4)				
	•						
		•	•	•	•	•	•
	45 kW - 55 kW (60 hp - 75 hp)	45 kW - 55 kW (60 hp - 75 hp)	75 kW - 90 kW (100 hp - 125 hp)	N/A	45 kW - 55 kW (60 hp - 75 hp)	75 kW - 90 kW (100 hp - 125 hp)	N/A
	90 kW - 110 kW (150 hp)	90 kW - 110 kW (150 hp)	132 kW - 160 kW (200 hp - 250 hp)	185 kW - 250 kW (300 hp - 400 hp)	90 kW - 110 kW (150hp)	132 kW - 160 kW (200 hp - 250 hp)	185 kW - 250 kW (300 hp - 400 hp)
	75 kW - 90 kW (100 hp - 125 hp)	75 kW - 90 kW (100 hp - 125 hp)	110 kW - 132 kW (150 hp - 200 hp)	150 kW - 225 kW (200 hp - 300 hp)	75 kW - 90 kW (100 hp - 125 hp)	110 kW - 132 kW (150 hp - 200 hp)	150 kW - 225 kW (200 hp - 300 hp)
	90 kW - 110 kW (125 hp - 150 hp)	90 kW - 110 kW (125 hp - 150 hp)	132 kW - 160 kW (175 hp - 200 hp)	185 kW - 250 kW (250 hp - 300 hp)	90 kW - 110 kW (125 hp - 150 hp)	132 kW - 160 kW (175 hp - 200 hp)	185 kW - 250 kW (250 hp - 300 hp)

\*Future availability

Modular ratings up to 2.8 MW (4,200 hp) through parallel connected inverters.

Dimensions include mounting brackets.

# MODULAR DRIVES

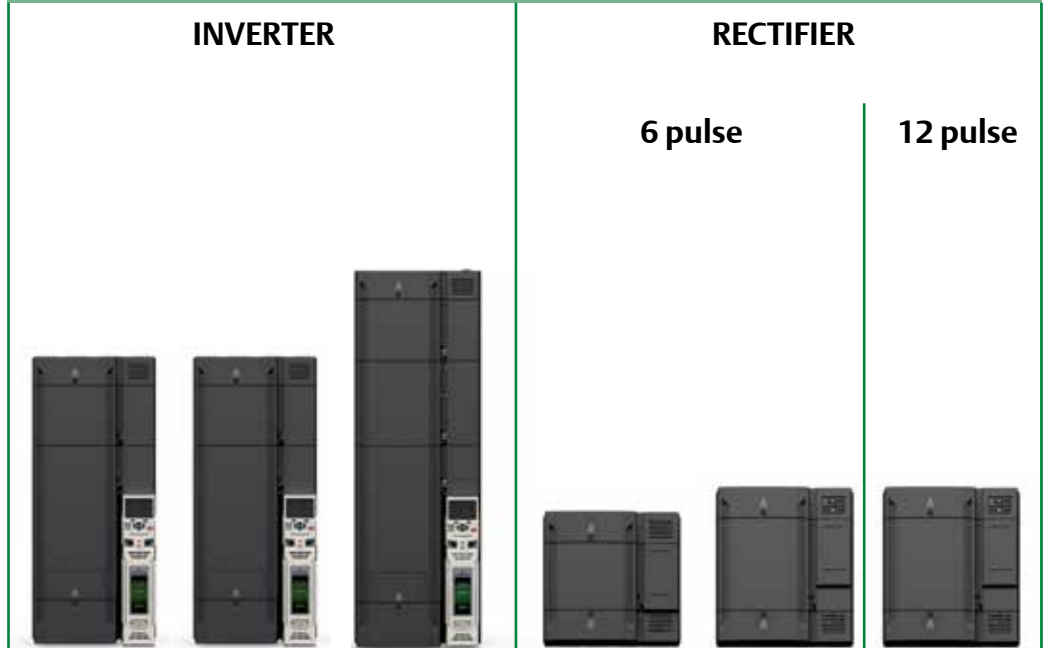

Frame size		9	10	11*	10	11*	11*
Dimensions (H x W x D)	mm	773 x 310 x 290	773 x 310 x 290	880 x 310 x 310	355 x 310 x 290	570 x 310 x 310	570 x 310 x 310
	in	30.4 x 12.2 x 11.4	30.4 x 12.2 x 11.4	34.7 x 12.2 x 12.2	15.8 x 12.2 x 11.4	22.4 x 12.2 x 12.2	22.4 x 12.2 x 12.2
Weight	kg (lb)						
Line Choke	Internal						
	External				•	•	•
Max Continuous Heavy Duty kW Rating / A Rating	@ 200 V	45 kW - 55 kW (60 hp - 75 hp)	75 kW - 90 kW (100 hp - 125 hp)	N/A	410 A	N/A	410 A
	@ 400 V	90 kW - 110 kW (150hp)	132 kW - 160 kW (200 hp - 250 hp)	185 kW - 250 kW (300 hp - 400 hp)	452 A	681 A	2 x 415 A
	@ 575 V	75 kW - 90 kW (100 hp - 125 hp)	110 kW - 132 kW (150 hp - 200 hp)	150 kW - 225 kW (200 hp - 300 hp)	248 A	485 A	2 x 398 A
	@ 690 V	90 kW - 110 kW (125 hp - 150 hp)	132 kW - 160 kW (175 hp - 200 hp)	185 kW - 250 kW (250 hp - 300 hp)			

Modular ratings up to 2.8 MW (4,200 hp) through parallel connected inverters.  
Dimensions include mounting brackets.

\*Future availability

# Unidrive M Range - Identification

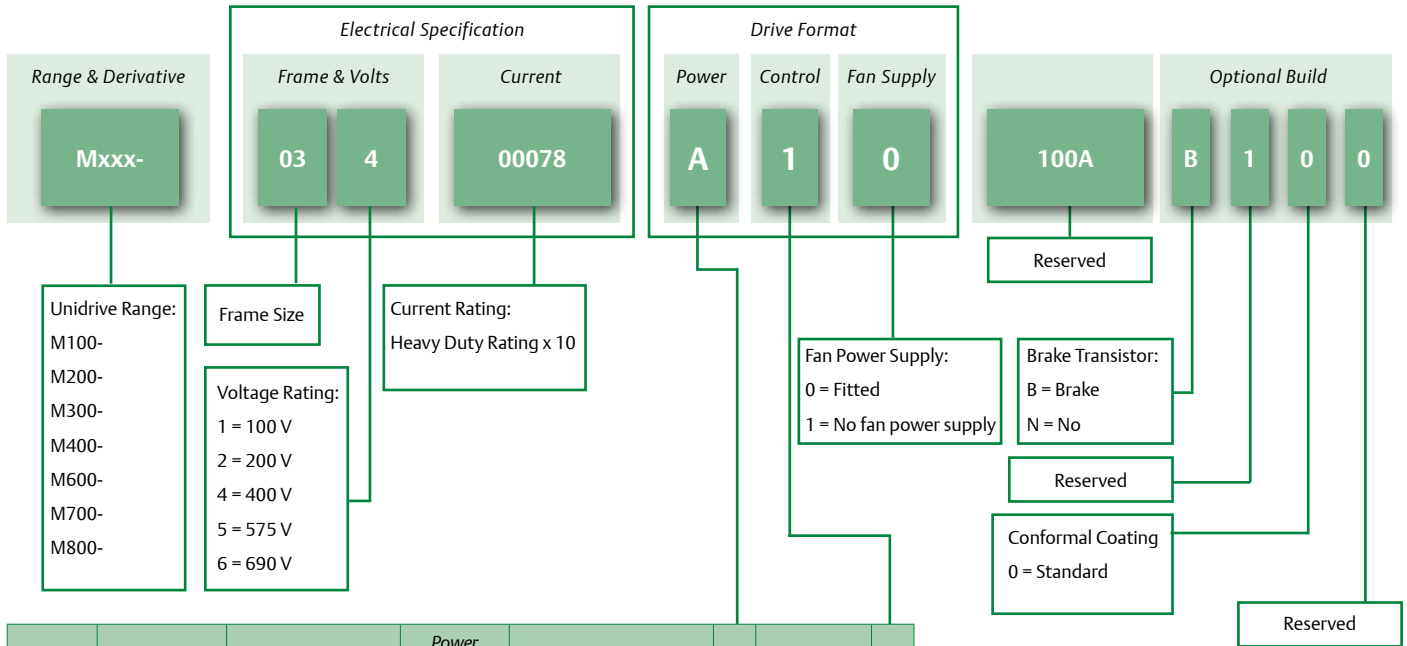

Frames	Range ID	Functionality	Power Description	Power Format	14	Control	15
03 to 09	Single drives Mxxx-	No paralleling. Control & fan power supply always fitted	AC to AC	<b>Internal Choke</b> 6P Rectifier + Inverter	A	Standard	1
09 to 11	Single drives Mxxx-	No paralleling. Control & fan power supply always fitted	AC to AC	<b>External Choke</b> (order separately) 6P Rectifier + Inverter	E	Standard	1
	Modular drives M000- (Unassigned power stage with no control fitted)	Can be paralleled. With or without fan power supply	DC to AC	12P Rectifier + Inverter	T	Unassigned	U
			DC to AC	18P Rectifier + Inverter	N	Master	M
				Inverter	D	Follower	F

Control Module Range for Unassigned Modular Drives
Mxxx-STANDARD011100A0100
Mxxx-MASTER00011100A0100
M000-FOLLOWER011100A0100

# Unidrive M Rectifier Range - Part Number

Supply Voltage	Power Supply	Frame	DC Output Current	Item Number
200 V	6 Pulse	10	410 A	RECT-10204100A10100A0100
400 V	6 Pulse	10	452 A	RECT-10404520A10100A0100
575 V	6 Pulse	10	243 A	RECT-10502430A10100A0100
690 V	6 Pulse	10	248 A	RECT-10602480A10100A0100

For a full list of patents and patent applications, visit [www.controltechniques.com/patents](http://www.controltechniques.com/patents).

EMERSON. CONSIDER IT SOLVED.™

[www.controltechniques.com](http://www.controltechniques.com)

**Products that increase productivity, reduce operating costs and maximize customer choice**

As part of Emerson Industrial Automation, Control Techniques and Leroy Somer are leading manufacturers of AC and DC variable speed drives, servos, motors and power conversion technologies for commercial and industrial applications. Our extensive range of innovative products are used in the most demanding applications requiring performance, reliability and energy efficiency, while providing the extensive features needed to maximize customer value and choice.



Our solutions are sold Worldwide through a network of over 90 Automation Centres and resellers in 70 countries. To locate an outlet near you, go to the website or send an email to [controltechniques@emerson.com](mailto:controltechniques@emerson.com).



© Emerson 2014. The information contained in this brochure is for guidance only and does not form part of any contract. The accuracy cannot be guaranteed as Emerson have an ongoing process of development and reserve the right to change the specification of their products without notice.